

KRW1/KRD1

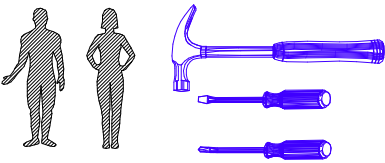

	Kód	Ks	Balení
1	404	1	3
2	405	1	3
3	406	1	1
4	103	1	1
5	104	1	1
6	002	2	1
7	502	3	1
8	652	1	2
9	605	1	3
10	604	1	2

A x12
(8x36)

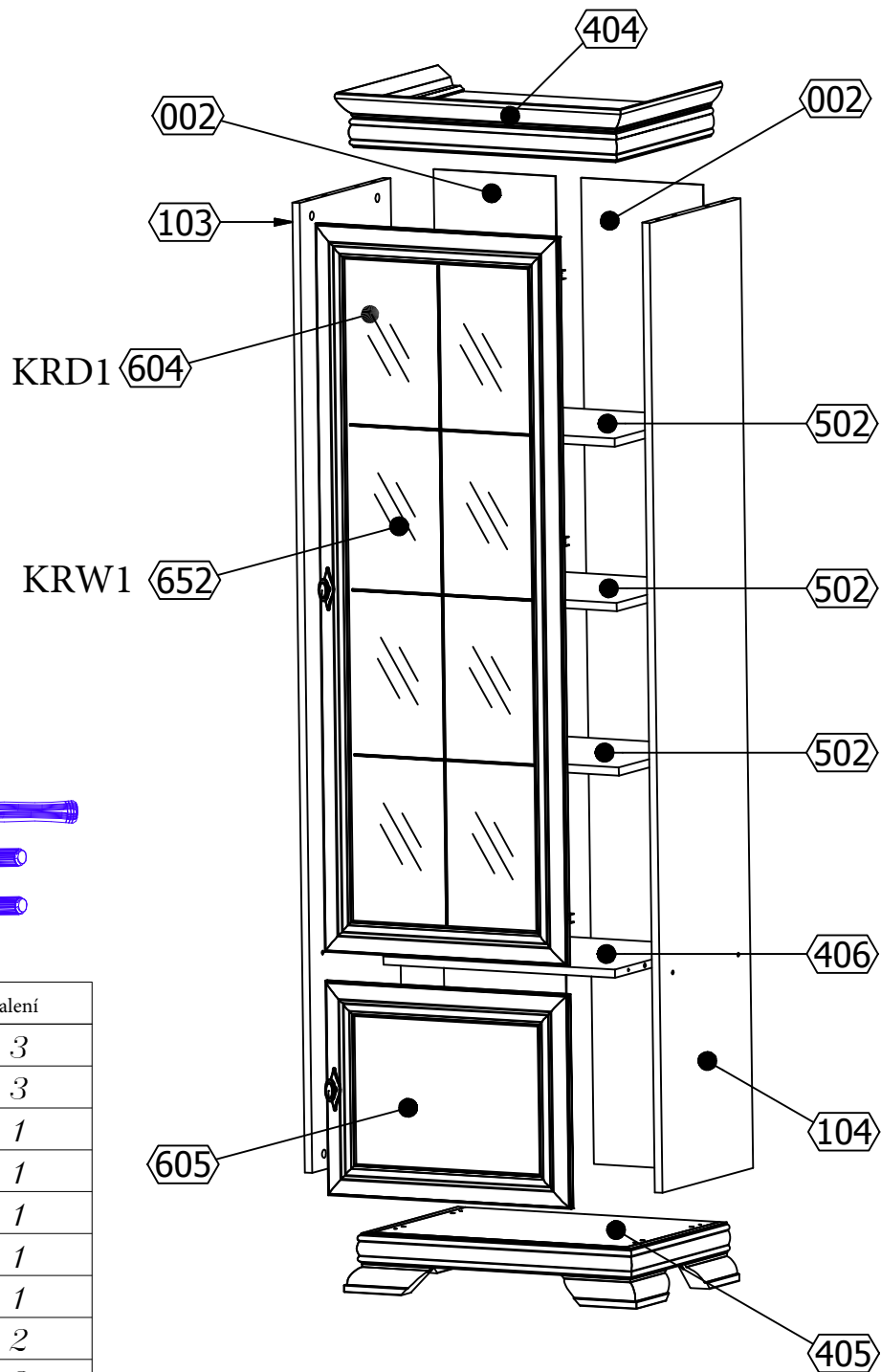
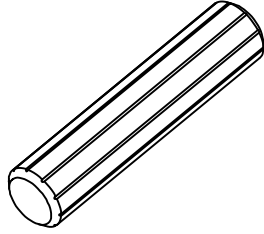

B x8

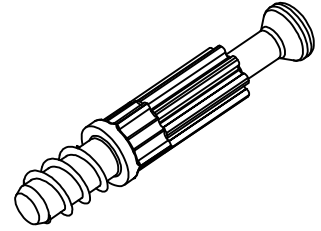

C x8
(Ø15x12)

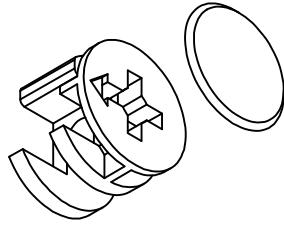

D x4

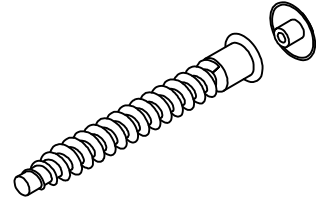

E x12

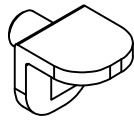

G x60

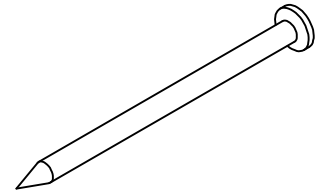

H x1

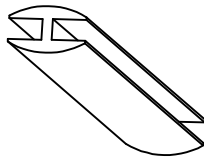

M x2



+

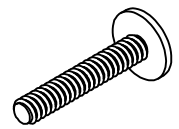

2 x X2 (M4x35)

W2 x10
(3,5x16)

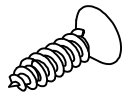

U x5

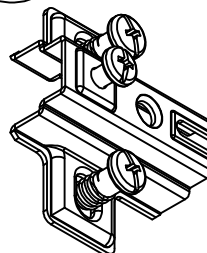

Uz

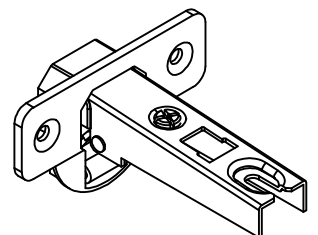

Uz1

Z x1

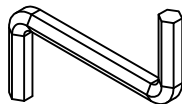

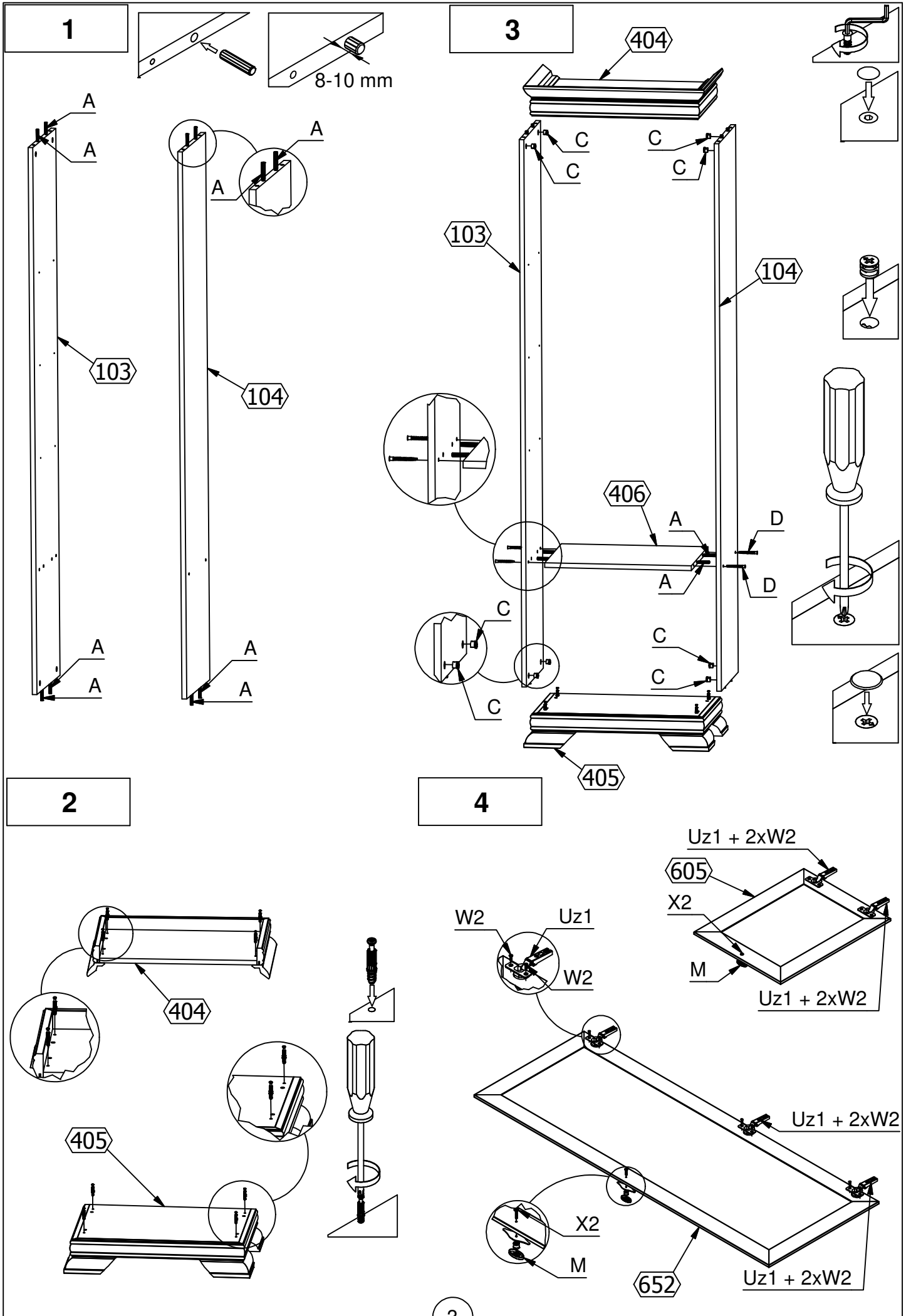

5

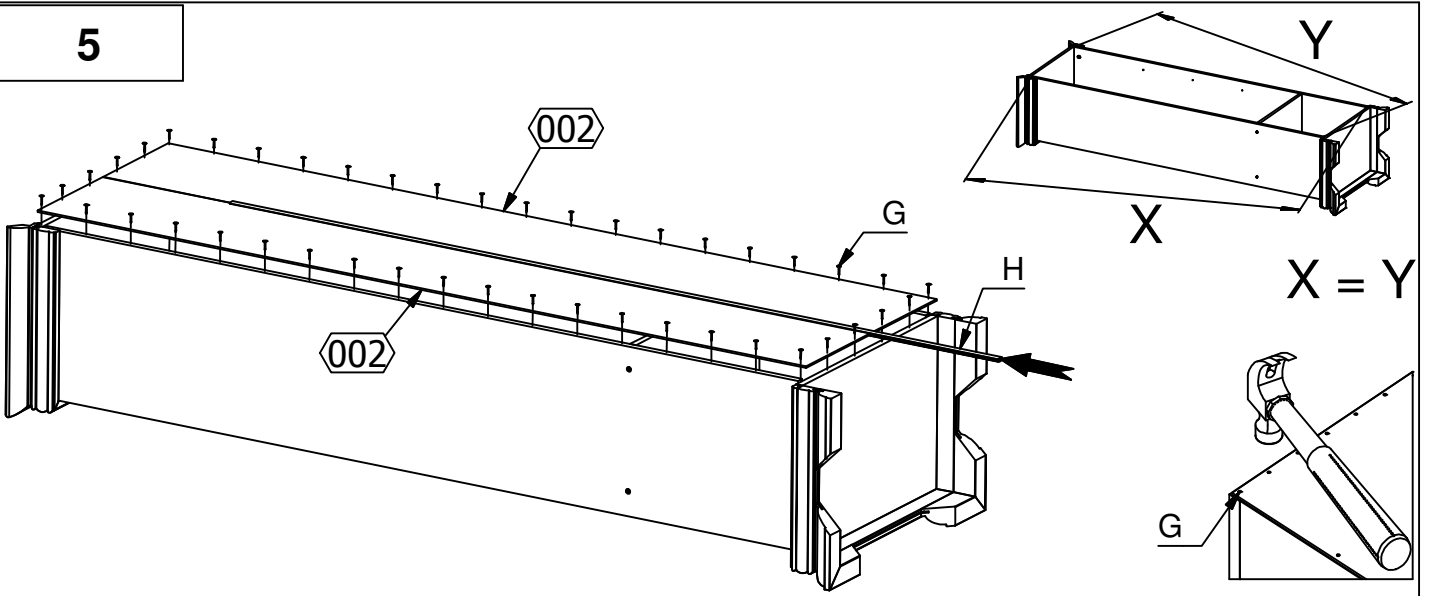

6

7

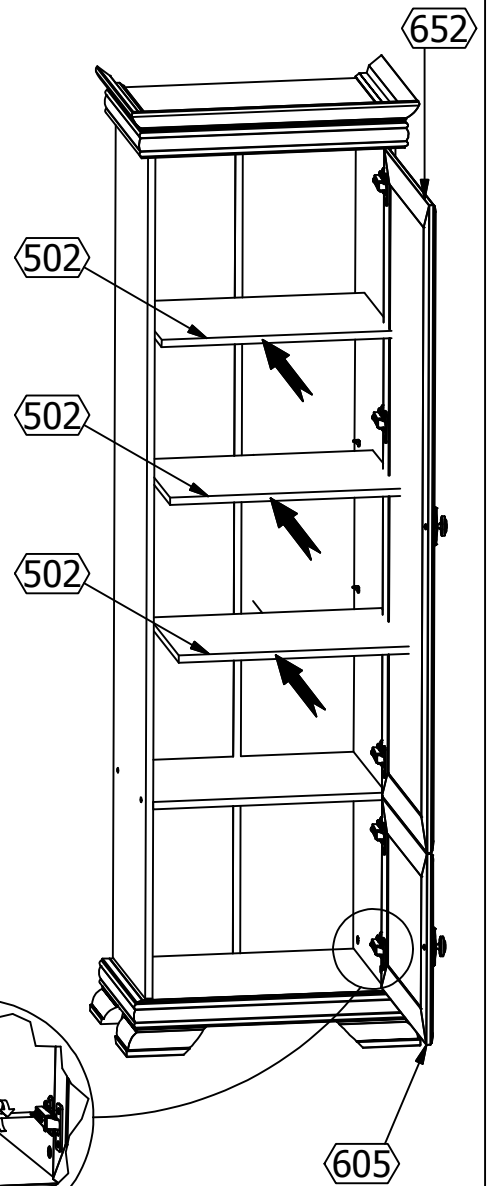
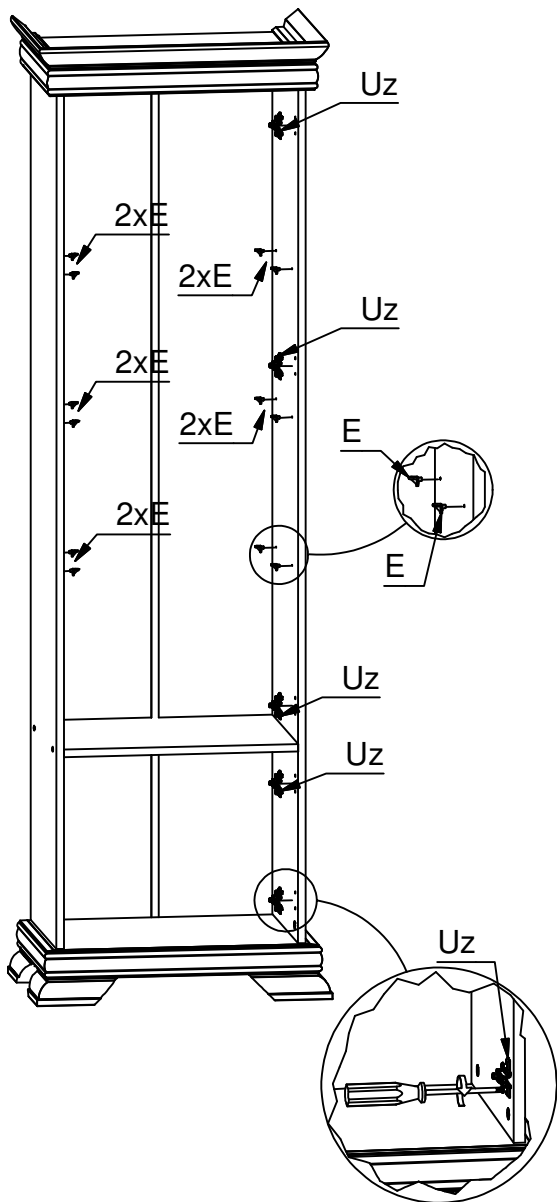

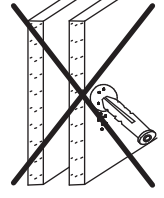
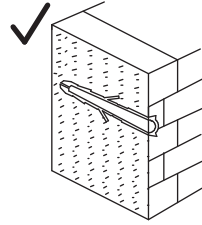
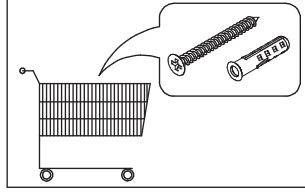
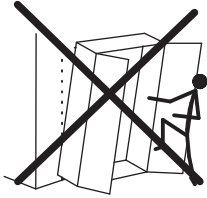
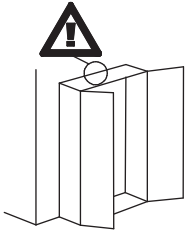

A

T4 x1

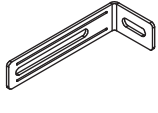

75x28x16 mm

W2 x2

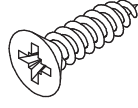

Ø3,5x16mm

B

T4 x2

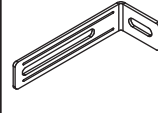

75x28x16 mm

W2 x4

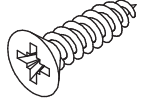

Ø3,5x16mm

